



Product: [N11R FF](#)

N11R, M26 x 1.5 thread, Field Attachable, Female, Angled, Grey housing, 60 V, 5 A, PG 11 w/ strain relief and clamping cage

Product Description

NR Circular Connector, M26 x 1.5 thread, Field Attachable, Female, Angled, 11+PE pins, Grey housing, 60 V, 5 A, PG 11 w/ strain relief and clamping cage

Technical Drawing

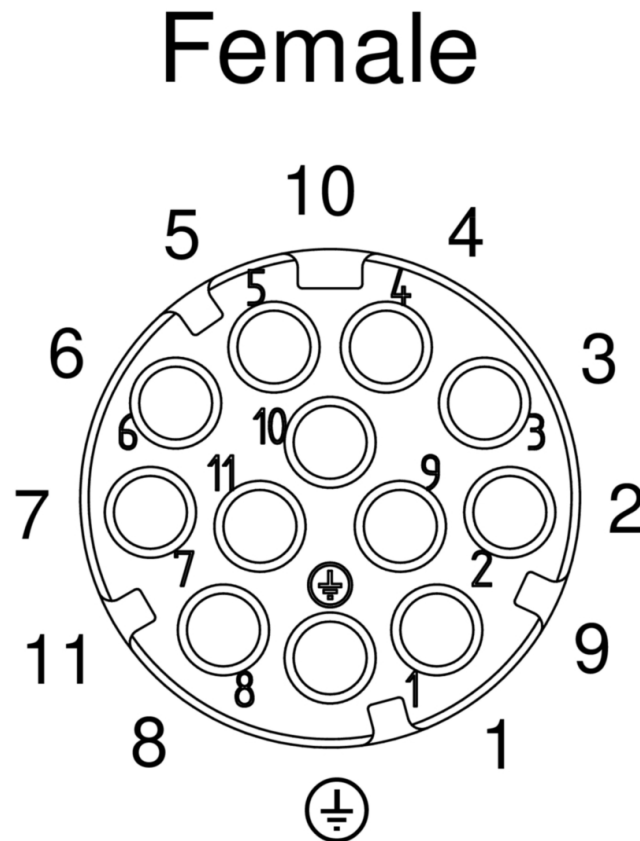
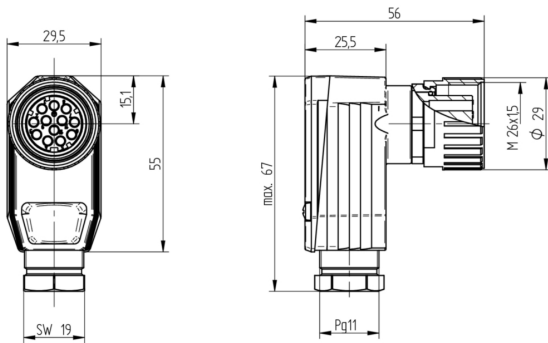

Technical Specifications

General Information

Note:	Do not connect or disconnect under load.
-------	--

Product description

Description:	Cable socket, angled
Housing Color:	grey
Number of Pins:	11+PE

Design Standard:	DIN 43 651
Strain-Relief:	clamping cage

Technical data

Clearance / Creepage Distance:	DIN EN 60664-1 (2008/01); VDE 0110-1
Contact Bearer Material:	PBT GF, grey
Contact material:	to order separate, see accessories
Contact Resistance:	≤ 5 mOhm
Pollution Degree:	3 acc. to DIN EN 60664-1 (VDE 0110-1)
Rated Current*:	5 A
Rated Impulse Voltage:	1,5 kV
Rated Voltage:	50 V AC / 60 V DC
Suitable Cables:	Ø8 mm to Ø10 mm
Type of Connection:	crimp
Type of Contact / Gender:	female

Product Materials

Gasket Material:	SBR/NBR
Housing Material:	PBT GF, grey

Environmental conditions

Protection Degree / IP Rating (IEC 60529):	IP65
--	------

Accessories

Accessories to Order Separately:	733-385-001: RBCB 162/1 Ag, crimp contact (on coil), 733-383-021: RBC 162/1 Ag, crimp contact (single)
Mating Connectors / Fitting to:	N11R AM..., appliance plug

Additional technical data

Fastening Torque (Cable Gland):	PG 11: (250-375) Ncm
Fastening torque (mounting screw):	M26x1,5: (100-150) Ncm

Other Standards

Variants

Item #	Item Description
932632106	N11R FF

Update and Revision:	Revision Number: 0.35 Revision Date: 10-27-2022
----------------------	---

© 2023 Belden, Inc

All Rights Reserved.

Although Belden makes every reasonable effort to ensure their accuracy at the time of this publication, information and specifications described here in are subject to error or omission and to change without notice, and the listing of such information and specifications does not ensure product availability.

Belden provides the information and specifications herein on an "ASIS" basis, with no representations or warranties, whether express, statutory or implied. In no event will Belden be liable for any damages (including consequential, indirect, incidental, special, punitive, or exemplary damages) whatsoever, even if Belden has been advised of the possibility of such damages, whether in an action under contract, negligence or any other theory, arising out of or in connection with the use, or inability to use, the information or specifications described herein.

All sales of Belden products are subject to Belden's standard terms and conditions of sale.

Belden believes this product to be in compliance with all applicable environmental programs as listed in the data sheet. The information provided is correct to the best of Belden's knowledge, information and belief at the date of its publication. This information is designed only as a general guide for the safe handling, storage, and any other operation of the product itself or the one that it becomes a part of. The Product Disclosure is not to be considered a warranty or quality specification. Regulatory information is for guidance purposes only. Product users are responsible for determining the applicability of legislation and regulations based on their individual usage of the product.