



Product: [GAN22LU-S24-603](#)

GAN DIN Standard Single-Ended Cordset: Form A, 3-pin (2+2PE), grey translucent body, with supressor diode and yellow LED, 24 V AC/DC, 10 A; PUR grey cable, 0.75 mm²

Product Description

GAN DIN Standard Single-Ended Cordset: Form A, 3-pin (2+2PE), grey translucent body, with supressor diode and yellow LED, 24 V AC/DC, 10 A; PUR grey cable, 0.75 mm²

Technical Drawing

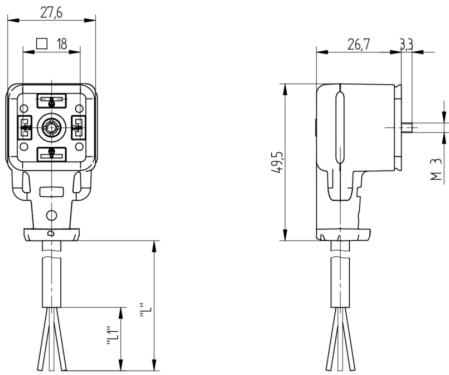

GAN22

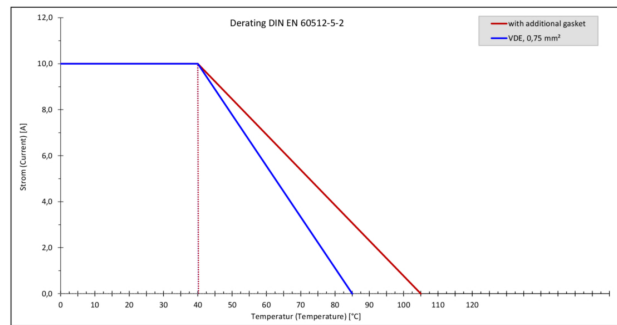
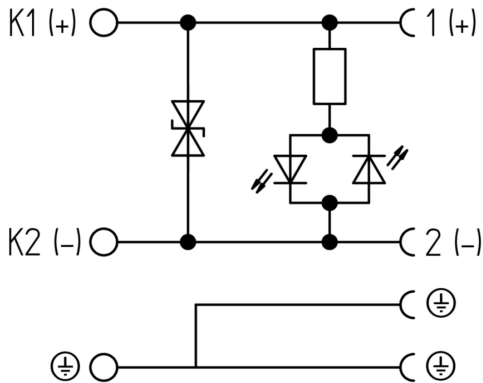
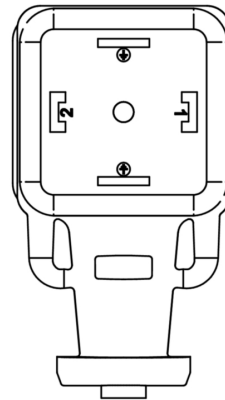

Technical Specifications

Face View

Pin 1	Pin 2	PE1	PE2
brown	blue	green-yellow	green-yellow

Technical Data

Product Family:	Valve Connectors
-----------------	------------------

Product Sub Family:	GAN
Brand:	Hirschmann
Connector Type:	Cordset, single ended
Type of Contact / Gender:	Female
Connector Design:	Angled
Number of Pins:	2+2 PE
Coding:	A
Shielding:	Unshielded
Attachment Type:	Central Screw
Rated Impulse Voltage:	4.0 kV (PCBA 2.0 kV)
Operating Voltage:	24 V AC/DC
Rated Current*:	10 A
Contact Resistance:	≤ 10 mOhm
Insulation Resistance:	> 10 ⁹ Ohm
Mating Cycles:	≤ 50
Ambient Temperature (Operation)*:	-25 °C - +85 °C (With additional 934-887-001 gasket : -40 °C - +105 °C)
Protection Degree / IP Rating**:	IP65, IP67 (IP69K: without additional gasket; max. +80 °C)
Design Standard:	DIN EN 175301-803-A, ISO 4400
Pollution Degree:	3 acc. to DIN EN 60664-1 (VDE 0110-1)
Clearance / Creepage Distance:	DIN EN 60664-1 (2008/01); VDE 0110-1
Overvoltage Category:	III acc. to DIN EN 60664-1 (VDE 0110-1)

Materials

Contact Base Material:	CuZn
Contact Plating:	Cu/Sn
Contact Bearer Material:	PA GF
Contact Bearer Color:	black
Flammability Class (Contact Bearer):	UL 94 V-0
Molded Body Material:	TPE
Molded Body Color:	Grey translucent
Flammability Class (Molded Body):	UL 94 HB
Attachment Material:	Steel, Philips combi slot
Gasket Material:	Molded Integrated Gasket

Protection Circuitry

Function Indicator:	Yellow LED
Protective Circuit:	Supressor diode

Additional Technical Data

Fastening Torque (Attachment):	(50-60) Ncm
--------------------------------	-------------

Cable Data

Cable Number:	603
Conductor Size:	0.75 mm ²
Number of Wires:	3
Minimal Bending Radius (Fixed Inst):	> 5 x D
Minimal Bending Radius (Flexible Inst):	> 7.5 x D
Conductor material:	Cu
Cable Jacket Material:	PUR
Cable Jacket Color:	grey
Cable Diameter D:	ø 5.80 ± 0.20 mm
Wire Insulation Material:	PP
Insulated Wire Diameter:	ø 1.92 ± 0.05 mm
Ambient Temperature (Fixed Installation):	- 50 °C - + 90 °C (UL: + 80 °C)
Ambient Temperature (Flex Installation):	- 25 °C - + 90 °C (UL: + 80 °C)

UL Cable Type:	AWM: 20549 or 21198
Flammability Class (Cable Jacket):	DIN EN 60332-1-2, VDE 0482-332-1-2, IEC 60332-1-2, CSA FT2; VDE 0472 Teil 804 Prüftart B
Cable Characteristics:	Good microbes and hydrolysis resistance; Mainly plasticizer diffusion free; good chemical and oil resistance; Exclusion of PVC and Silicone; free of lacquer wetting disturbing substances; Coldness flexibility

Approvals

VDE:	yes
------	-----

Safety & Environmental Compliance

RoHS Compliant:	yes
-----------------	-----

Resistances

Halogenfree:	yes
Oil Resistance:	IEC 60811-404 , VDE 0472; VDE 0250

Notes

Note Derating:	Notice derating
Protection Degree / IP Rating Note:	** only if mounted and locked in combination with Hirschmann / Lumberg Automation connector.
Note:	Do not connect or disconnect under load.

Variants

Item #	Item Description	Cable Length	Replacement For
934889105	GAN22LU-S24-6030200-1UC	2 m	ID: 934562069 Name: GAN-DFFE7X-DN0200C1-XC607-AD
934889106	GAN22LU-S24-6030500-1UC	5 m	ID: 934562064 Name: GAN-DFFE7X-DN0500C1-XC607-AC
934889165	GAN22LU-S24-6030150	1.5 m	ID: 934562070 Name: GAN-DFFE7X-FV0150C1-XC607-AD
934889166	GAN22LU-S24-6030180	1.8 m	ID: 934562057 Name: GAN-DFFE7X-FV0180C1-XC607-AD
934889161	GAN22LU-S24-6031500-1UB	15 m	ID: 934562091 Name: GAN-DFFE7X-FS1500C1-XC607-AA
934889162	GAN22LU-S24-6032000-1UH	20 m	ID: 934562092 Name: GAN-DFFE7X-FS2000C1-XC607-AC
934889163	GAN22LU-S24-6032500	25 m	ID: 934562093 Name: GAN-DFFE7X-FS2500C1-XC607-AC
934889164	GAN22LU-S24-6033000-1UA	30 m	ID: 934562088 Name: GAN-DFFE7X-FS3000C1-XC607-AA

© 2024 Belden, Inc

All Rights Reserved.

Although Belden makes every reasonable effort to ensure their accuracy at the time of this publication, information and specifications described here in are subject to error or omission and to change without notice, and the listing of such information and specifications does not ensure product availability.

Belden provides the information and specifications herein on an "ASIS" basis, with no representations or warranties, whether express, statutory or implied. In no event will Belden be liable for any damages (including consequential, indirect, incidental, special, punitive, or exemplary damages) whatsoever, even if Belden has been advised of the possibility of such damages, whether in an action under contract, negligence or any other theory, arising out of or in connection with the use, or inability to use, the information or specifications described herein.

All sales of Belden products are subject to Belden's standard terms and conditions of sale.

Belden believes this product to be in compliance with all applicable environmental programs as listed in the data sheet. The information provided is correct to the best of Belden's knowledge, information and belief at the date of its publication. This information is designed only as a general guide for the safe handling, storage, and any other operation of the product itself or the one that it becomes a part of. The Product Disclosure is not to be considered a warranty or quality specification. Regulatory information is for guidance purposes only. Product users are responsible for determining the applicability of legislation and regulations based on their individual usage of the product.